

Precision Dressing Tools
Rotary Diamond Dressers



Rotary Diamond Dressers

These Dressers shape grinding wheels in the shortest possible time. Their features:

- Profiling grinding wheels in one step through plunge grinding
- Profiling from the simplest work piece to the most complicated shape
- Meeting exacting precision demands
- Offering high economic efficiency



Diamond Form Rolls

These Form Rolls shape grinding wheels in automatically controlled CNC dressing operations. Their features:

- Profiling grinding wheels by moving the diamond form roll along the required contour
- Profiling from the simplest work piece to the most complicated shape
- Meeting exacting precision demands
- Offering high economic efficiency



Diamond Dressing Blocks

These Dressing Blocks are ideal alternatives to Rotary Dressing Wheels in applications where mechanical dressing is considered un-economical. These can be mounted by using simple attachments to machines.



Selection of Dressing Tools

Type NZ (randomly distributed diamonds)

Type NS (hand set diamonds)

Type NM (hand set / randomly distributed diamonds)

These Tools are produced by reverse plating method.

In this Diamond grain is actively involved in the dressing action, leading to long service life. These types of rolls are used for intricate profiles & tighter tolerances NZ type dominates in application of almost all types of profiles, especially where surface finish is important. NM type is preferred where work pieces are prone to grinding burn.



Type IZ (randomly distributed diamonds)

Type IS (hand set diamonds)

These tools are produced by infiltration in the reverse method.

These types of tools can meet critical tolerance levels. IZ type tools, depending on the profile, ensures shorter manufacturing cycles. The IS type is particularly suitable for profiles with intricate links that cannot be produced by reverse plated method. Both IZ and IS types are extremely robust in construction.

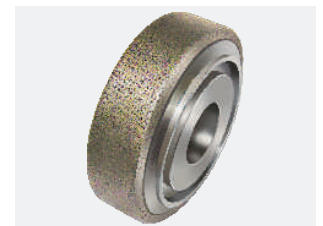

Type PM (diamonds randomly distributed)

These tools are produced by direct plating.

Due to random distribution of abrasive grits, the surface of the rotary dresser is relatively rough and uneven. These tools are therefore extremely aggressive and achieve rougher surface finish. Thus they are not suitable for applications that call for high accuracies. The body can be recoated more than once, contributing to economic efficiency of the tool. Also their manufacturing cost is relatively low.



Type SM (diamonds interspersed)

These types of tools are produced by sintering, using mixture of diamond and bond.

While the grit size equals the thickness of the coating in all types of abrasive tools, only in this type it is possible to obtain thickness in multiples of the grit size. Thickness of 2, 3 or 5 mm are standard. Since these types of dressers cannot be produced to a high degree of accuracy, they are ideal for simple profiles.

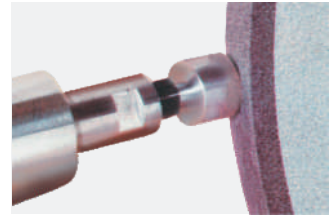

Pre-conditions for Dressing

Grinding Machine

Rotary Diamond dressing applications place high demands:

On rigidity of the grinding machine

On the precision of spindle bearing

On travel and infeed

Both the drive unit and grinding wheel must be balanced to a high degree in order to prevent potential vibrations, which could result in geometry errors or poor surface quality of the work piece.



Dressing Equipment

Wendt offers a wide range of dressing equipment for a host of applications that require high tolerances. These can be mounted to form rotary diamond dressers which can be installed on standard grinders or integrated into special grinders with appropriate modifications.

To absorb high dressing forces, the mountings of profile rolls should always be supported on both sides (outboard support style spindle) by mandrels. However mountings of from rolls could be supported by mandrels on side (cantilever style spindle), since the dressing forces are low due to their short contact length.

Dressing equipment applications require infinitely variable drives and reversible rotational directions for random selection of down cuts or up cuts.

Sufficient power should be ensured to maintain constant speed for the dressing operation with even the largest roll diameter. The required power depends on specification of the dresser and grinding wheel, working parameters, in feed direction, rotational direction in down cut or up cut dressing and contact length.

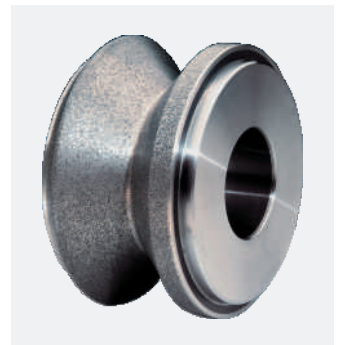

Cooling System

Selection of a cooling system for dressing application is as important as it is for the actual grinding application. For maximum effectiveness the coolant:

Must be supplied at the correct flow rate

Must be in the rotational direction of the grinding wheel

Flow should be aimed at the contact area of the grinding wheel / dressing tool

Should be supplied through profile adjusted supply jets for deep profiles.



Diamond Form Rolls

The rapid development and introduction of CNC controlled dressing processes with Diamond Form Rolls has produced a host of designs. Catering to all these designs is neither economically feasible nor technically advisable.

However, Wendt has developed standards for Form Rolls as illustrated in the table below. This reduces the diversity within manageable limits which in turn ensures process economy through cost effective manufacture. It also helps delivery from ready stock.

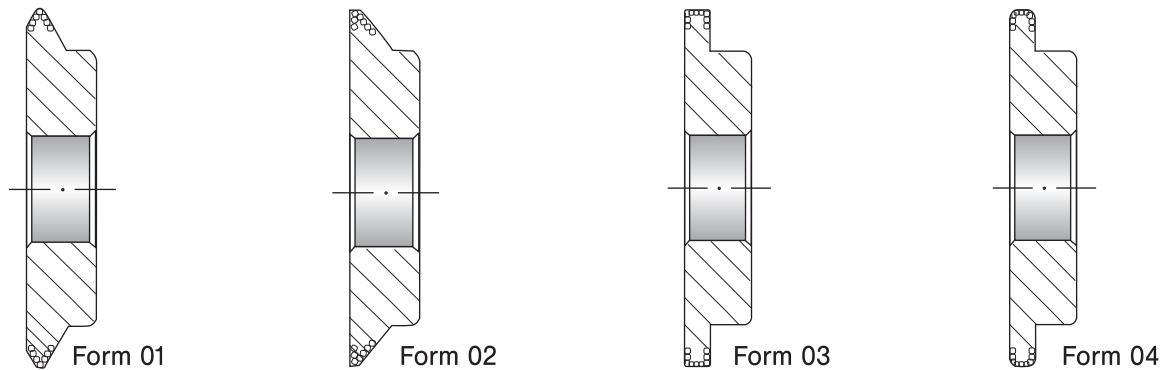

Selection of Form Rolls

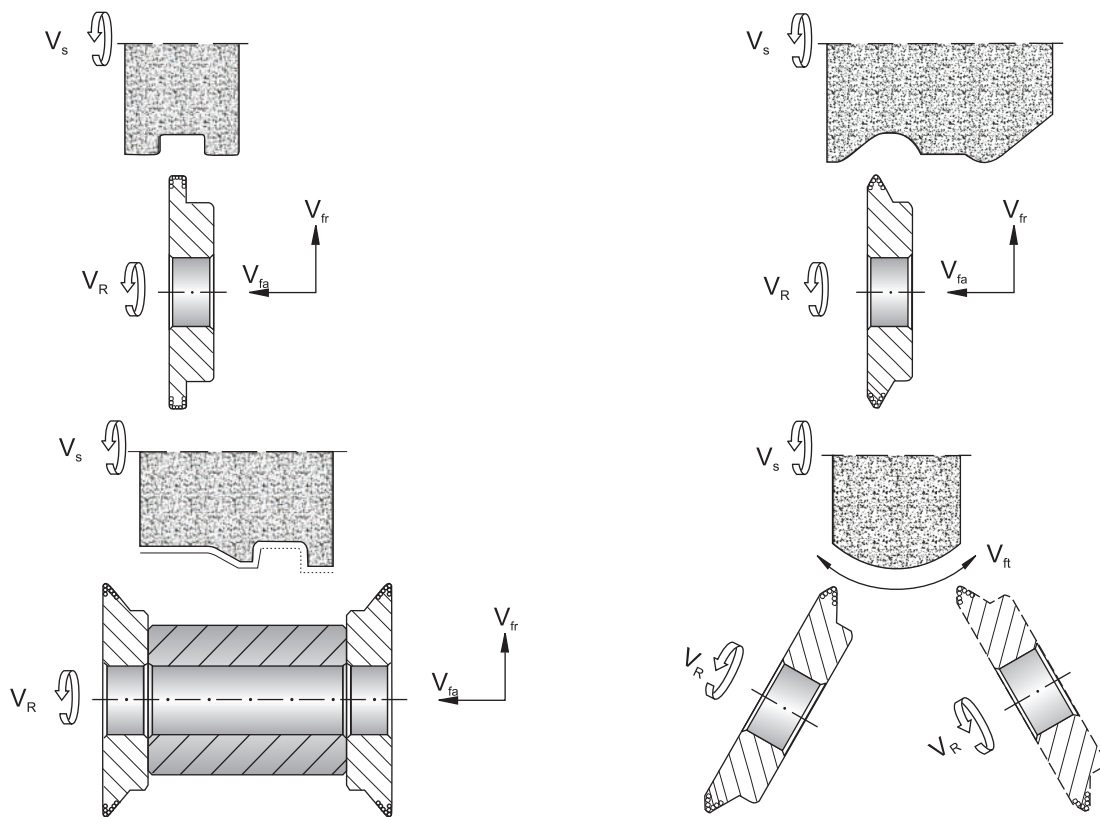

Advantages of Form Rolls

Quick transfer of different profile shapes to Vitrified Bonded Grinding Wheels

Low production costs for small and medium numbers of work pieces

Low dressing costs thanks to long service life of diamond form rolls

Repeated re-profiling is possible



Operating Conditions

Rotary Diamond Dressers offer a host of applications through the choice of operating conditions, configuration of axes, rotational directions, speed ratios, dwell and in feed in dressing operations.

Rotational Direction

Rotational direction of the rotary diamond dresser normally decides whether dressing should take place with a down cut or up cut.

Since, down cut dressing results in coarse surface finish, it is preferred for dressing rough grinding wheel at high performance rates. It is also ideal for precision grinding of critical profiles that are prone to grinding burns. By changing the speed ratio in down cut dressing, the surface finish can be influenced over larger areas.

However Up cut dressing results in finer surfaces finish. It is suitable for dressing precision grinding wheels with non critical profiles not prone to grinding burns.

Speed Ratio (Q_d)

Surface finish is influenced by the change in the Speed Ratio, which is the result of dividing dresser's peripheral speed VR by grinding wheel's peripheral speed VS. The drawings clearly illustrate the influence in up cut and down cut dressing with different in-feeds.

Feed Rate (v)

The application of diamond form rolls requires an additional parameter - feed movement - with speeds in axial (V_{fa}) and radial (V_{fr}) or tangential (V_{ft}) direction. Higher infeed, especially in down cut dressing, results in coarser surface finish. Feed rate also dependance on the combination of application and operating condition.

Dwell (n_a)

Surface finish is also affected by the number of dwell revolutions (n_a). Increasing number of dwell revolutions, especially in down cut dressing, results in less coarse surface finish. Refer the above drawing. If there is a possibility of grinding burns, the number of dwell revolutions should be kept to a minimum. For higher surface roughness the dwell revolutions should be increased.

Infeed (a_d)

The radial in feed a_d (μm) of the rotary diamond dresser per grinding wheel revolution is chosen as the characteristic value for the infeed. Higher infeed, especially in down cut dressing, results in coarser surface finish. Recommended infeeds: $0.25 - 0.5 \mu\text{m}$ / grinding wheel revolution. To re-establish grinding wheel profile, the infeed should be less than 0.03 mm .

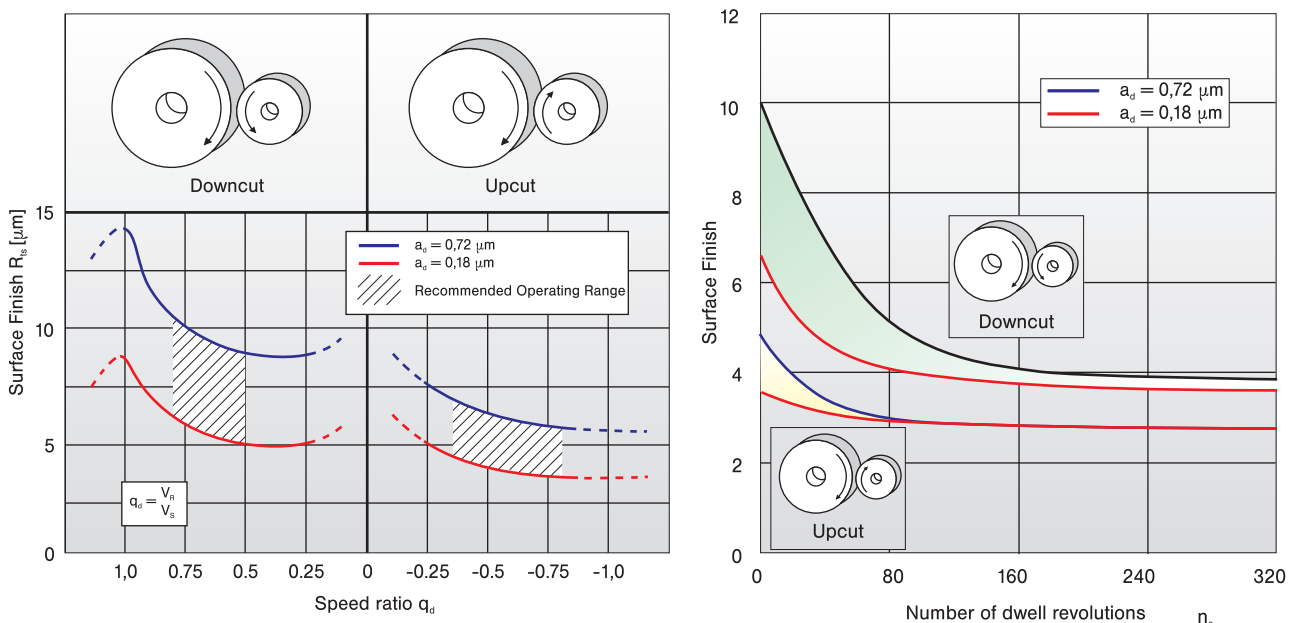

Typical Applications

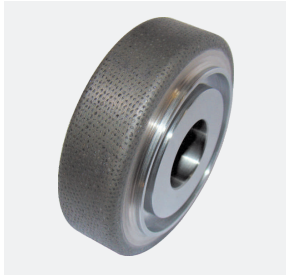

Roller Type :
Infiltrated Form Roller

Applications:
Journal and Pin grinding on Landis,
Newall, Toyoda, Saimp

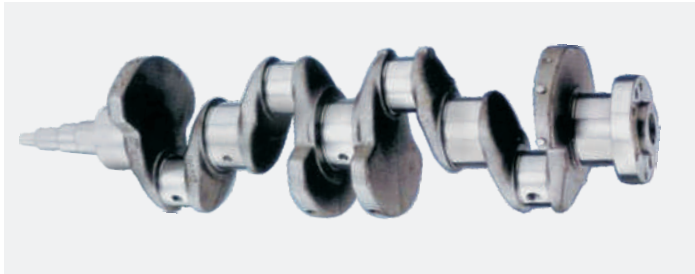

Roller Type :
Reverse Plated

Applications:
Turbine Blade and
Vane Component



Roller Type :
Reverse Plated & Infiltrated

Applications:
Deep groove/Angular contact/Taper
roller ball bearings, Water pump
bearings



Roller Type :
Infiltrated/Reverse Plated

Applications:
Engine Valve end stem
Groove/Chamfer grinding



Roller Type :
Infiltrated Form Roller

Applications:
Camshaft grinding for Landis, NTC,
Toyoda and Saimp machines



Roller Type :
Infiltrated/Positive Plated Disc
type dresser

Applications:
DSA/SPA/RP2 Dressing
system



WENDT (INDIA) LTD.

69/70, Sipcot Industrial Complex, Hosur-635 126, Tamil Nadu.
Ph: +91-4344-276851, 276852, 276254, 405500, 405501.
Fax: +91-4344-405620, E-mail: wil@wendtindia.com

Regional Offices:

● AURANGABAD ● BANGALORE ● BARODA ● BELGAUM ● CHENNAI ● COIMBATORE ● DELHI ● FARIDABAD ● HARIDWAR
● HOSUR ● HYDERABAD ● INDORE ● JAIPUR ● JAMSHEDPUR ● KOLKATA ● MUMBAI ● NAGPUR ● NASHIK ● PUNE

Visit us at www.wendtindia.com

For more information contact:
E-mail: rathinamp@wendtindia.com
venkateshms@wendtindia.com